

Data sheet article OTN-25

Technical data and application safety

Webcraft GmbH
Industriepark 206
78244 Gottmadingen, Germany

Phone: +49 7731 939 839 2

www.supermagnete.es
support@supermagnete.es

1. Technical information

Article ID	OTN-25
EAN	7640155435420
Material	NdFeB
Strength	approx. 18 kg (approx. 177 N)
Displacement force	approx. 3,6 kg (approx. 35300 N)
Pot diameter D	25 mm
Neck diameter d	8 mm
Pot height H1	7 mm
Total height without eyelet H2	14 mm
Total height with eyelet H3	30 mm
Thread M	4
Eyelet inside diameter a	4 mm
Magnetisation	N38
Coating	nickel-coated (Ni-Cu-Ni)
Max. working temperature	80°C
Steel	Q235 (China)
Weight	28,5000 g

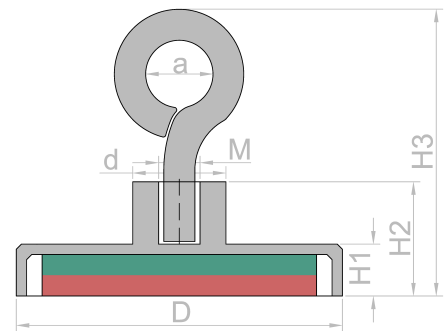

Pollutant-free according to RoHS Directive 2011/65/EU.

2. Safety tips

Danger 	Swallowing Children could swallow small magnets. If several magnets are swallowed, they could get stuck in the intestine and cause perilous complications. Magnets are not toys! Make sure that children don't play with magnets.
Warning 	Contusions Big magnets have a very strong attractive force. • Unsafe handling could cause jamming of fingers or skin in between magnets. This may lead to contusions and bruises. • Powerful, very large magnets could cause bone fractures. Wear heavy protective gloves when handling larger magnets.

<p>Warning</p> 	<p>Pacemaker</p> <p>Magnets could affect the functioning of pacemakers and implanted heart defibrillators.</p> <ul style="list-style-type: none"> • A pacemaker could switch into test mode and cause illness. • A heart defibrillator may stop working.
	<ul style="list-style-type: none"> • If you wear these devices keep sufficient distance to magnets: www.supermagnete.es/eng/faq/distance • Warn others who wear these devices from getting too close to magnets.

<p>Warning</p> 	<p>Heavy objects</p> <p>Too heavy loads, symptoms of fatigue as well as material defect could cause a magnet or magnetic hook to loosen from the surface that it was attached to.</p> <p>Falling objects could lead to serious injuries.</p>
	<ul style="list-style-type: none"> • The indicated adhesive force applies only to ideal conditions. Allow for a high safety cushion. • Don't use magnets in places where people could sustain injuries in case of material failure.

<p>Warning</p> 	<p>Metal splinters</p> <p>Neodymium magnets are brittle. Colliding magnets could crack.</p> <p>Sharp splinters could be catapulted away for several meters and injure your eyes.</p>
	<ul style="list-style-type: none"> • Avoid the collision of magnets. • Wear safety glasses when handling larger magnets. • Make sure that nearby people are also protected or keep their distance.

3. Handling and storing

<p>Caution</p> 	<p>Magnetic field</p> <p>Magnets produce a far-reaching, strong magnetic field. They could damage TVs and laptops, computer hard drives, credit and ATM cards, data storage media, mechanical watches, hearing aids and speakers.</p>
	<ul style="list-style-type: none"> • Keep magnets away from devices and objects that could be damaged by strong magnetic fields. • Please refer to our table of recommended distances: www.supermagnete.es/eng/faq/distance

<p>Caution</p> 	<p>Combustibility</p> <p>When machining magnets, the drilling dust could easily ignite.</p>
	<p>Stay away from machining magnets or use appropriate tools and sufficient cooling water.</p>

<p>Caution</p> 	<p>Nickel allergy</p> <p>Many of our magnets contain nickel, also those without nickel coating.</p> <ul style="list-style-type: none"> • Some people have an allergic reaction when they come into contact with nickel. • Nickel allergies could develop from perpetual contact with nickel-plated objects.
	<ul style="list-style-type: none"> • Avoid perpetual skin contact with magnets. • Avoid contact with magnets if you already have a nickel allergy.

<p>Notice</p> 	<p>Influence on people</p> <p>According to the current level of knowledge, magnetic fields of permanent magnets do not have a measurable positive or negative influence on people. It is unlikely that permanent magnets constitute a health risk, but it cannot be ruled out entirely.</p>
	<ul style="list-style-type: none"> • For your own safety, avoid constant contact with magnets. • Store large magnets at least one metre away from your body.

	Notice Splintering of coating
	<p>Most of our neodymium magnets have a thin nickel-copper-nickel coating to protect them from erosion. This coating could splinter or crack due to collision or large pressure. This makes them vulnerable to environmental influences like moisture and they could oxidise.</p> <ul style="list-style-type: none"> • Separate big magnets, especially spheres, with a piece of cardboard. • Avoid collisions of magnets as well as repeated mechanical exposure (e.g. blows, bashes).

	Notice Oxidation, corrosion, rust
	<p>Untreated neodymium magnets oxidise quickly and disintegrate. Most of our magnets have a nickel-copper-nickel coating to protect them from corrosion. This coating provides some protection against corrosion, but it is not robust enough for continuous outdoor use.</p> <ul style="list-style-type: none"> • Use magnets only in the dry indoors or protect them against environmental influences. • Avoid damages to the coating.

	Notice Temperature resistance
	<p>Neodymium magnets have a maximum working temperature of 80 to 200°C. Most neodymium magnets lose part of their adhesive force permanently at a temperature of 80°C.</p> <ul style="list-style-type: none"> • Don't use magnets in places where they are exposed to extreme heat. • If you use an adhesive, don't harden it with hot air.

	Notice Mechanical treatment
	<p>Neodymium magnets are brittle, heat-sensitive and oxidise easily.</p> <ul style="list-style-type: none"> • When drilling or sawing a magnet with improper tools, the magnet may break. • The emerging heat may demagnetise the magnet. • The magnet will oxidise and disintegrate due to the damaged coating. <p>Avoid machining magnets if you do not have the necessary machines and experience. Let us provide you with an offer for a custom-made order instead: www.supermagnete.es/eng/custom_form.php</p>

4. Transportation tips

	Caution Airfreight
	<p>Magnetic fields of improperly packaged magnets could influence airplane navigation devices. In the worst case it could lead to an accident.</p> <ul style="list-style-type: none"> • Airfreight magnets only in packaging with sufficient magnetic shielding. • Please refer to the respective regulations: www.supermagnete.es/eng/faq/airfreight

	Caution Postage
	<p>Magnetic fields of improperly packaged magnets could cause disturbances in sorting machines and damage fragile goods in other packages.</p> <ul style="list-style-type: none"> • Please refer to our shipping tips: www.supermagnete.es/eng/faq/shipping • Use a large box and place the magnet in the middle surrounded by lots of padding material. • Arrange magnets in a package in a way that the magnetic fields neutralise each other. • If necessary, use sheet iron to shield the magnetic field. • There are stricter rules for airfreight: Refer to the warning notice "Airfreight".

5. Disposal tips

Small amounts of used neodymium magnets can be thrown out with the regular trash. Larger amounts of magnets need to be recycled as scrap metal.

6. Statutory provisions

Neodymium magnets are not intended for sale/export to the United States of America, Canada or Japan. You are strictly prohibited from directly or indirectly exporting the neodymium magnets that you received from us or the end products that you produced from those magnets to the countries mentioned above.

TARIC-Code: 8505 1100 99 0

Origin: China

For more information about magnets please review
www.supermagnete.es/faq.php.

Last update: 16/12/2019